

P3 **T16*12*8** **C/P**
Material **Core Size** **Coating**
 材质 品名 涂装

C=Epoxy. P=Parylene.

Dimensions: (UNIT:mm)

Dimensions(mm)			
Epoxy Coating Dimensions(mm)			
ΦD1	ΦD2	H	Wt(g/set)
16.0±0.40	12.0±0.30	8.00±0.30	3.35
16.90max	11.1 min	8.90 max	

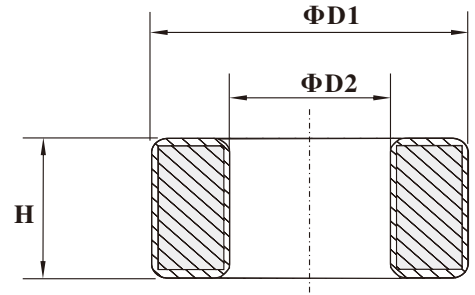
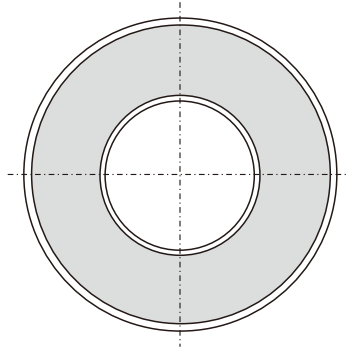

Test Conditions

AL: F=10.0KHz U=0.3V N=10Ts

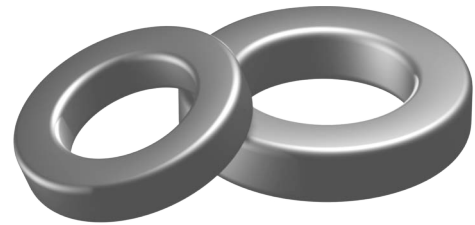

Effective parameter

	Ve(mm3)	Ae(mm2)	Le(mm)
	689	15.9	43.4

Coating

The core are coated with epoxy, flame retardant in accordance with "UL 94V-0" file number E228348. The colour is green.

Ring core data

GRADE	AL(nH)	μi	TYPE NUMBER
P3	1100±25%	≈2300	T16/12/8/P3
H5K	2300±25%	≈5000	T16/12/8/H5K
H7K	3200±25%	≈7000	T16/12/8/H7K
H10K	4600±30%	≈10000	T16/12/8/H10K

Note:

- 1: Document is the property of FUAN Inc & is not allowed to be duplicated without authorization
- 2: RoHS compliant.

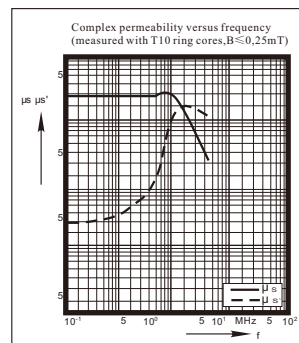

P3

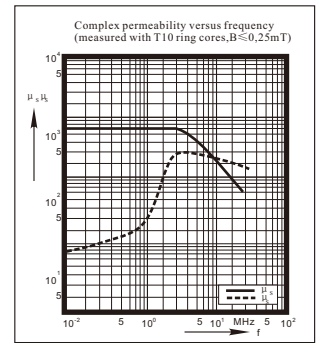

H5K

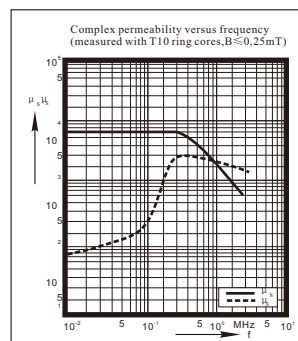

H7K

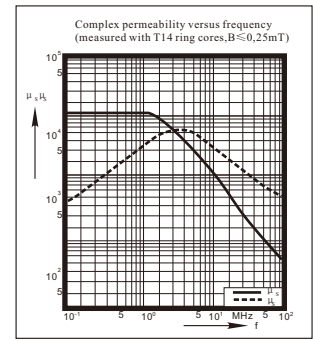

H10K