

P3 **T17*10*8** **C/P**
Material **Core Size** **Coating**
 材质 品名 涂装

C=Epoxy. P=Parylene.

Ferrite core

Dimensions: (UNIT:mm)

Dimensions(mm)			Wt(g/set)
ΦD1	ΦD2	H	
17.0±0.40	10.0±0.30	8.0±0.30	4.88
18.10max	9.10min	8.90max	

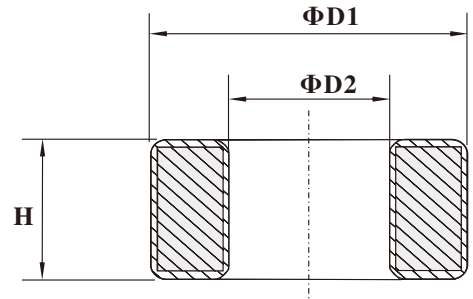
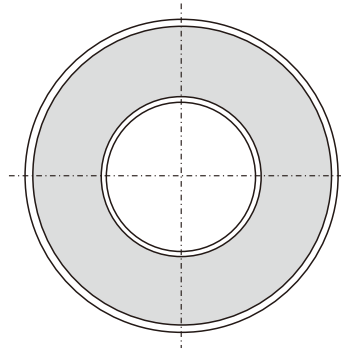

Test Conditions

AL: F=10.0KHz U=0.3V N=10Ts

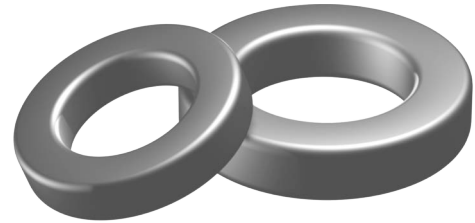

Effective parameter

	Ve(mm ³)	Ae(mm ²)	Le(mm)
	1159	28.0	41.4

Coating

The core are coated with epoxy, flame retardant in accordance with "UL 94V-0" file number E228348.

The colour is green.

Ring core data

GRADE	AL(nH)	μi	TYPE NUMBER
P3	1200±25%	≈2300	T17/10/8/P3
H5K	4200±25%	≈5000	T17/10/8/H5K
H7K	5900±25%	≈7000	T17/10/8/H7K
H10K	8500±30%	≈10000	T17/10/8/H10K

Note:

- 1: Document is the property of FUAN Inc & is not allowed to be duplicated without authorization
- 2: RoHS compliant.

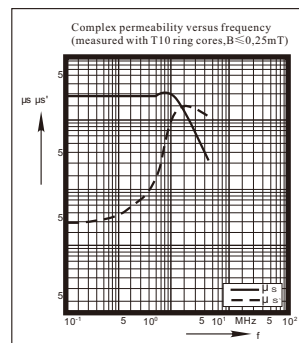

P3

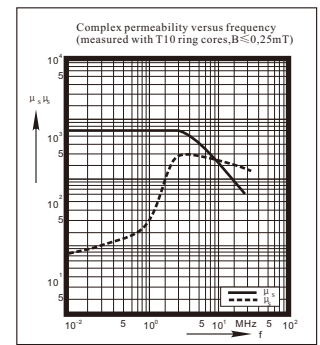

H5K

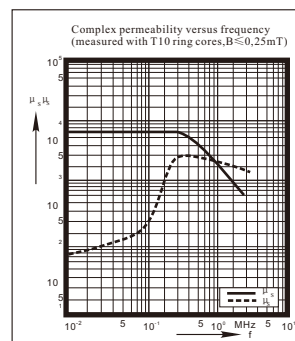

H7K

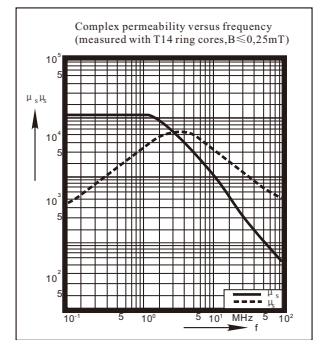

H10K