



**PAIRUI**

Http: [fuantronics.com](http://fuantronics.com)

**P3**    **T2.54\*1.27\*1.27**    **HP**  
**Material**    **Core Size**    **Coating**  
 材质    品名    涂装

HP: Parylene Coating of Ja; pgem-Free

## Ferrite core

### Dimensions: (UNIT:mm)

Dimensions(mm)			
Parylene Coating Dimensions(mm)			
ΦD1	ΦD2	H	Wt(g/set)
2.54±0.2	1.27±0.15	1.27±0.15	0.03
2.54±0.2	1.27±0.15	1.27±0.15	

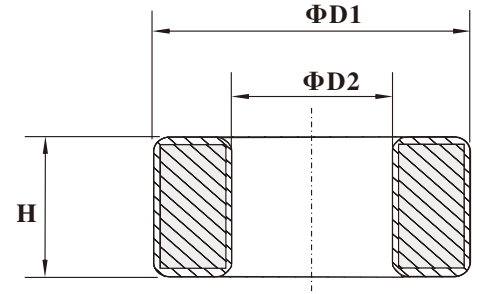
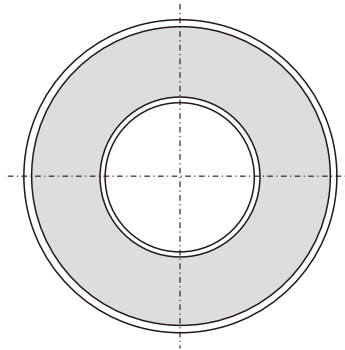

### Test Conditions

AL: F=10.0KHz    U=0.3V    N=10Ts

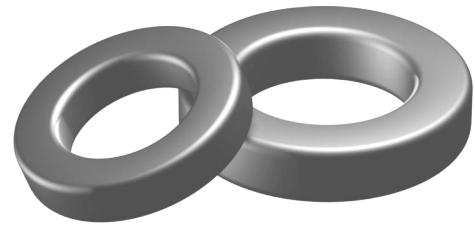

### Effective parameter

	Ve(mm <sup>3</sup> )	Ae(mm <sup>2</sup> )	Le(mm)
	4.268	0.075	5.531

### Coating

The core are coated with epoxy, flame retardant in accordance with "UL 94V-0" file number E228348.

The colour is green.

### Ring core data

GRADE	AL(nH)	μi	TYPE NUMBER
P3	440±25%	≈2300	T2.54/1.27/1.27/P3
H5K	880±25%	≈5000	T2.54/1.27/1.27/H5K
H7K	1320±25%	≈7000	T2.54/1.27/1.27/H7K
H10K	1761±30%	≈10000	T2.54/1.27/1.27/H10K

### Note:

- 1: Document is the property of FUAN Inc & is not allowed to be duplicated without authorization
- 2: RoHS compliant.

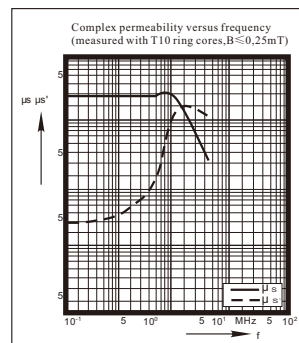

P3

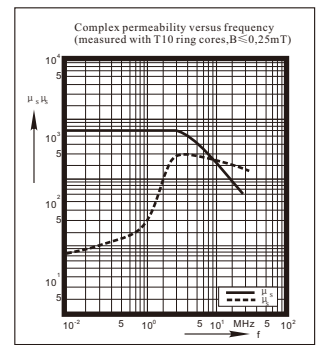

H5K

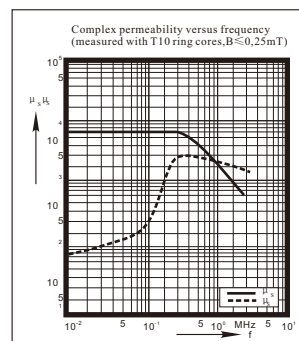

H7K

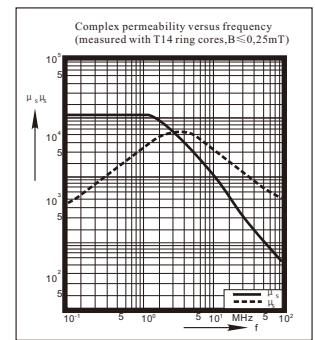

H10K