

**P3**    **T22.1\*13.7\*12.7**    **C/P**  
**Material**    **Core Size**    **Coating**  
 材质    品名    涂装

C=Epoxy.    P=Parylene.

**Dimensions: (UNIT:mm)**

Dimensions(mm)			
Epoxy Coating Dimensions(mm)			
ΦD1	ΦD2	H	Wt(g/set)
22.1±0.40	13.7±0.40	12.7±0.30	13.50
23.1max	12.8min	13.6max	

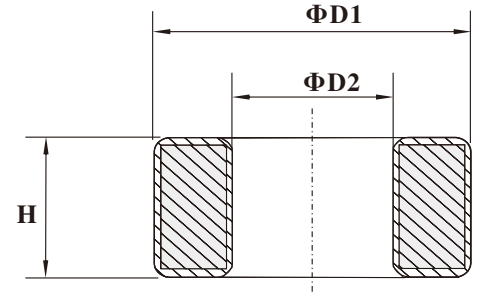
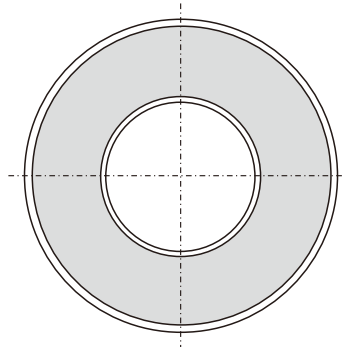

**Ferrite core**

**Test Conditions**

AL: F=10.0KHz    U=0.3V    N=10Ts

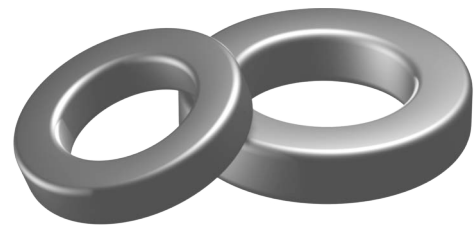

**Effective parameter**

	Ve(mm3)	Ae(mm2)	Le(mm)
	2860	52.8	54.1

**Coating**

The core are coated with epoxy, flame retardant in accordance with "UL 94V-0" file number E228348. The colour is green.

**Ring core data**

GRADE	AL(nH)	μi	TYPE NUMBER
P3	2900±25%	≈2300	T22.1/13.7/12.7/P3
H5K	6100±25%	≈5000	T22.1/13.7/12.7/H5K
H7K	8500±25%	≈7000	T22.1/13.7/12.7/H7K
H10K	12000±30%	≈10000	T22.1/13.7/12.7/H10K

**Note:**

- 1: Document is the property of FUAN Inc & is not allowed to be duplicated without authorization
- 2: RoHS compliant.

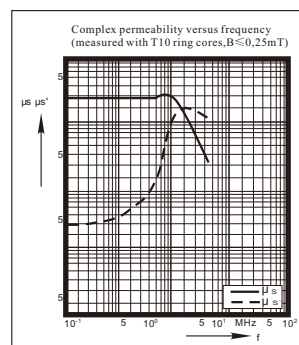

P3

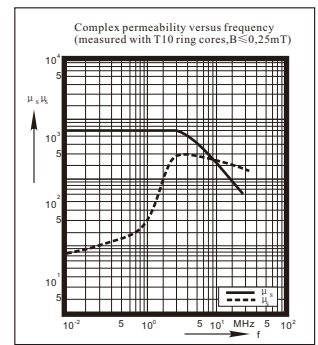

H5K

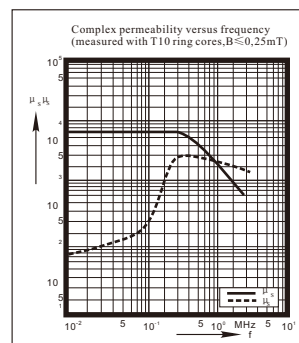

H7K

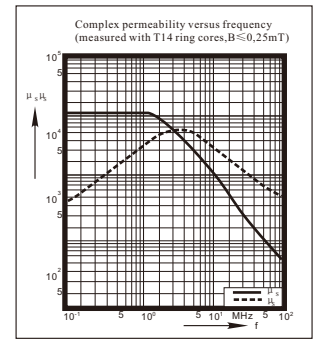

H10K