

P3 **T22*14*10** **C/P**
Material **Core Size** **Coating**
 材质 品名 涂装

C=Epoxy. P=Parylene.

Dimensions: (UNIT:mm)

Dimensions(mm)			
Epoxy Coating Dimensions(mm)			
ΦD1	ΦD2	H	Wt(g/set)
22.0±0.40	14.0±0.40	10.0±0.30	10.84
23.0max	13.00min	10.90max	

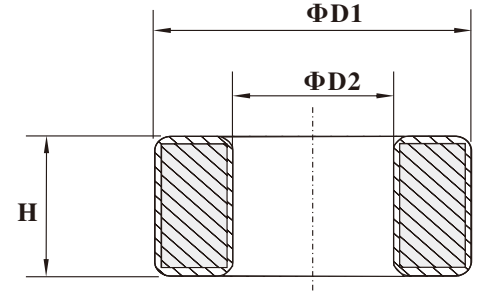
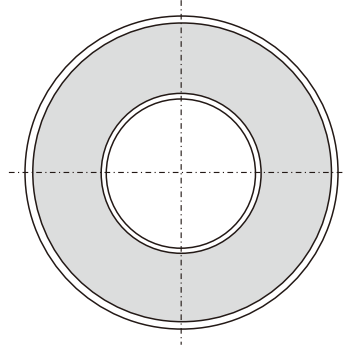

Test Conditions

AL: F=10.0KHz U=0.3V N=10Ts

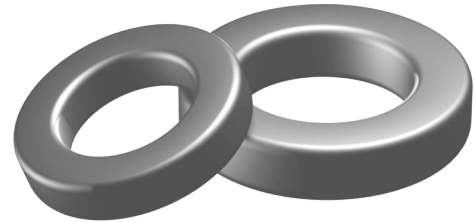

Effective parameter

	Ve(mm3)	Ae(mm2)	Le(mm)
	2150	39.3	54.7

Coating

The core are coated with epoxy, flame retardant in accordance with "UL 94V-0" file number E228348. The colour is green.

Ring core data

GRADE	AL(nH)	μi	TYPE NUMBER
P3	2250±25%	≈2300	T22/14/10/P3
H5K	4500±25%	≈5000	T22/14/10/H5K
H7K	6300±25%	≈7000	T22/14/10/H7K
H10K	9000±30%	≈10000	T22/14/10/H10K

Note:

- 1: Document is the property of FUAN Inc & is not allowed to be duplicated without authorization
- 2: RoHS compliant.

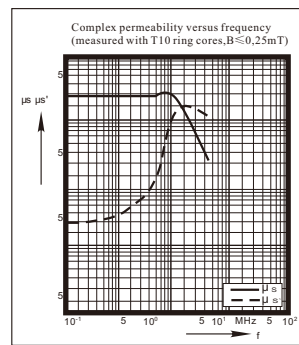

P3

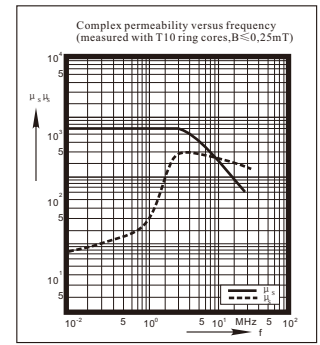

H5K

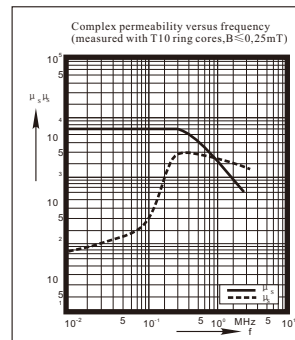

H7K

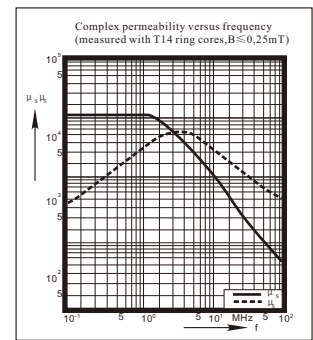

H10K