

P3 **T3.05*1.78*1.27** **HP**
Material **Core Size** **Coating**
 材质 品名 涂装

HP:Parylene Coating of Ja;pgem-Free

Dimensions: (UNIT:mm)

| | | | |
|---------------------------------|----------|-----------|-----------|
| Dimensions(mm) | | | |
| Parylene Coating Dimensions(mm) | | | |
| ΦD1 | ΦD2 | H | Wt(g/set) |
| 3.05±0.25 | 1.78±0.2 | 1.27±0.15 | 0.04 |
| 3.05±0.25 | 1.78±0.2 | 1.27±0.15 | |

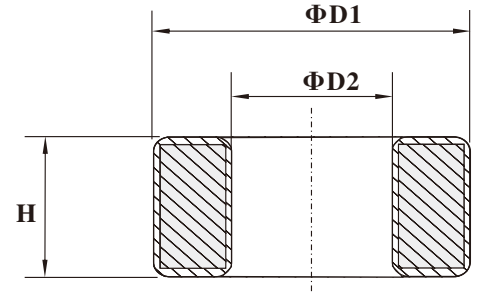
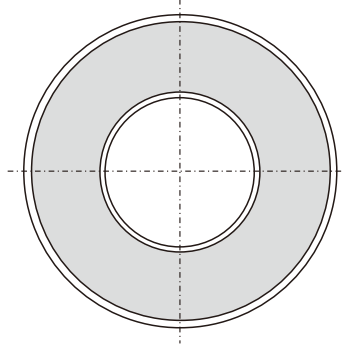

Test Conditions

AL: F=10.0KHz U=0.3V N=10Ts

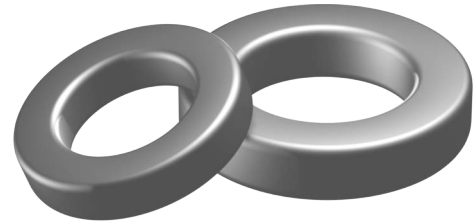

Effective parameter

| | | | |
|--|---------|---------|--------|
| | Ve(mm3) | Ae(mm2) | Le(mm) |
| | 5.688 | 1.035 | 7.226 |

Coating

The core are coated with epoxy, flame retardant in accordance with "UL 94V-0" file number E228348. The colour is green.

Ring core data

| GRADE | AL(nH) | μi | TYPE NUMBER |
|-------|----------|--------|----------------------|
| P3 | 320±25% | ≈2300 | T3.05/1.78/1.27/P3 |
| H5K | 685±25% | ≈5000 | T3.05/1.78/1.27/H5K |
| H7K | 1027±25% | ≈7000 | T3.05/1.78/1.27/H7K |
| H10K | 1369±30% | ≈10000 | T3.05/1.78/1.27/H10K |

Note:

- 1: Document is the property of FUAN Inc & is not allowed to be duplicated without authorization
- 2: RoHS compliant.

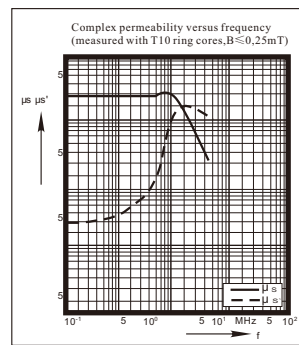

P3

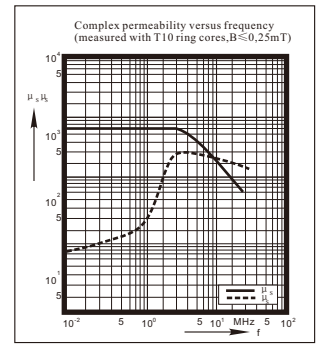

H5K

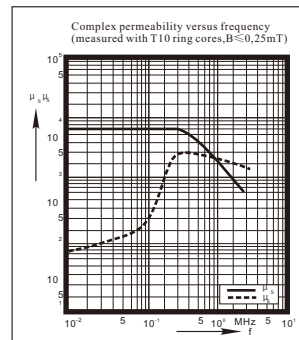

H7K

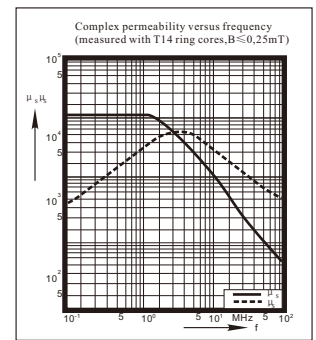

H10K