

P3 **T46*31*12** **C/P**
Material **Core Size** **Coating**
 材质 品名 涂装

C=Epoxy. P=Parylene.

Dimensions: (UNIT:mm)

Dimensions(mm)			
Epoxy Coating Dimensions(mm)			
ΦD1	ΦD2	H	Wt(g/set)
46.0±0.50	31.0±0.50	12.0 ±0.40	50.8
47.4max	29.6min	13.00max	

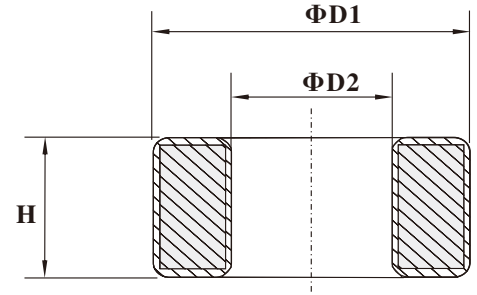
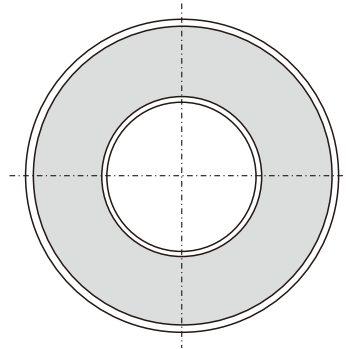

Ferrite core

Test Conditions

AL: F=10.0KHz U=0.3V N=10Ts

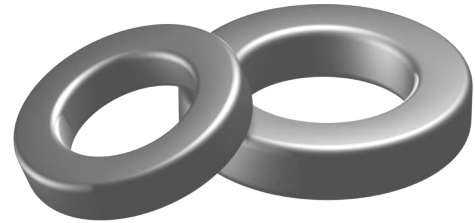

Effective parameter

	Ve(mm3)	Ae(mm2)	Le(mm)
	10600	93	114

Coating

The core are coated with epoxy, flame retardant in accordance with "UL 94V-0" file number E228348. The colour is green.

Ring core data

GRADE	AL(nH)	μi	TYPE NUMBER
P3	2500±25%	≈2300	T46/31/12/P3
H5K	5100±25%	≈5000	T46/31/12/H5K
H7K	7200±25%	≈7000	T46/31/12/H7K
H10K	10300±30%	≈10000	T46/31/12/H10K

Note:

- 1: Document is the property of FUAN Inc & is not allowed to be duplicated without authorization
- 2: RoHS compliant.

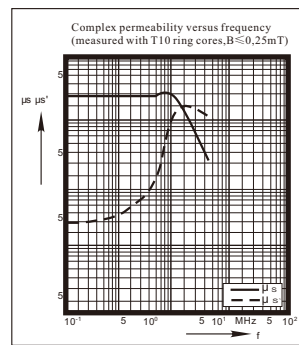

P3

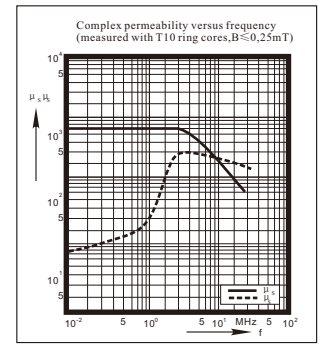

H5K

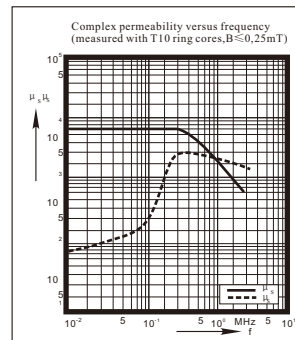

H7K

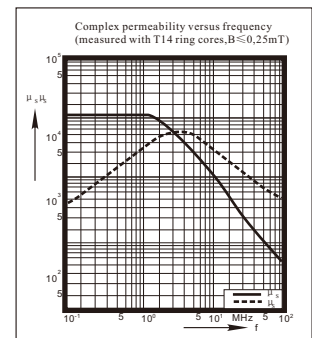

H10K