



**PAIRUI**

Http:fuantronics.com

**P3**      **T4\*2\*1**      **HP**  
**Material**    **Core Size**    **Coating**  
 材质            品名            涂装

HP:Parylene Coating of Ja;pgem-Free

**Dimensions: (UNIT:mm)**

Dimensions(mm)			
Parylene Coating Dimensions(mm)			
ΦD1	ΦD2	H	Wt(g/set)
4.0±0.3	2.0±0.2	1.0±0.1	0.06
4.0±0.3	2.0±0.2	1.0±0.1	

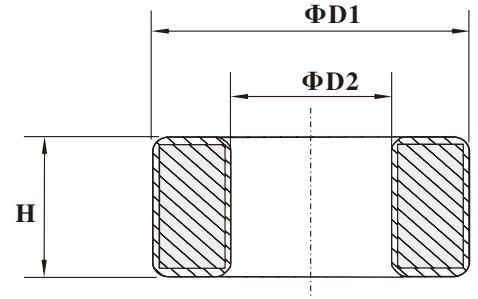
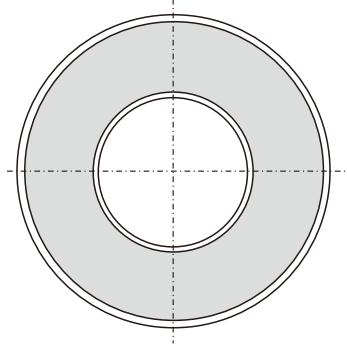

**Test Conditions**

AL: F=10.0KHz    U=0.3V    N=10Ts

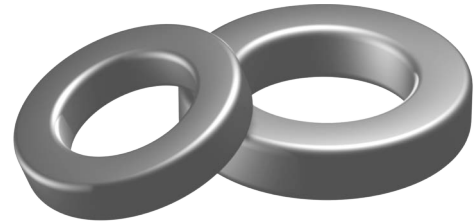

**Effective parameter**

	Ve(mm3)	Ae(mm2)	Le(mm)
	9.06	1.0	9.06

**Coating**

The core are coated with epoxy, flame retardant in accordance with "UL 94V-0" file number E228348. The colour is green.

**Ring core data**

GRADE	AL(nH)	μi	TYPE NUMBER
P3	330±25%	≈2300	T4/2/1/P3
H5K	690±25%	≈5000	T4/2/1/H5K
H7K	970±25%	≈7000	T4/2/1/H7K
H10K	1400±30%	≈10000	T4/2/1/H10K

**Note:**

- 1: Document is the property of FUAN Inc & is not allowed to be duplicated without authorization
- 2: RoHS compliant.

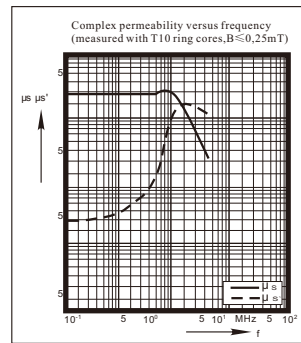

P3

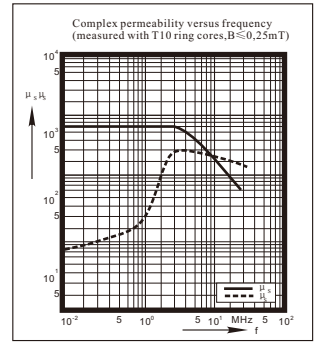

H5K

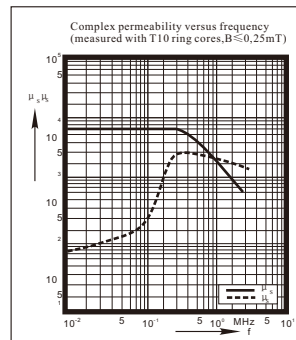

H7K

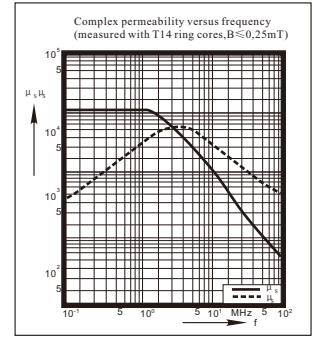

H10K